

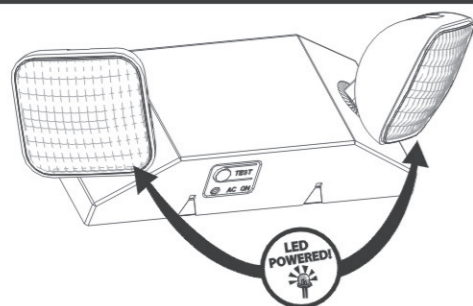

Model # 55501201

Instructions for LED Emergency Lighting Fixture



IMPORTANT :
Let the battery charge up for at least 24 hours. Then normal operation of this unit should take effect. To check, press the "TEST" button. The LED lamps on the unit should turn ON. During an electrical power failure, the led lamps will automatically come on for a minimum of 90 minutes. In accordance with NFPA 101, your emergency lighting system must be tested monthly for a minimum of 30 seconds and annually for 90 minutes. Refer to your local codes for any additional requirements that may apply.

IMPORTANT SAFEGUARDS

When using electrical equipment, basic safety precautions should always be followed including the following:

READ AND FOLLOW ALL SAFETY INSTRUCTIONS

1. Do not use outdoors.
2. Equipment should be mounted in locations and at heights where it will not be subject to tampering by unauthorized personnel.
3. Do not mount near gas or electric heaters.
4. The use of accessory equipment not recommended by the manufacturer may cause an unsafe condition.
5. Do not use this equipment for anything other than its intended use.
6. Servicing of this equipment should be performed by qualified personnel.
7. Disconnect AC power before servicing.

SAVE THESE INSTRUCTIONS

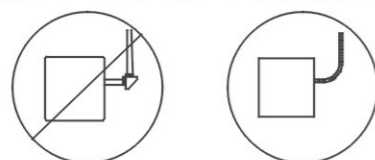

FLEXIBLE CONDUIT ONLY

INSTALLATION (J-BOX MOUNTING)

1. Feed fixture leads through the back plate and connect to AC power supply (Fig A). For 120V use black and white wires and for 277V, use red and white wires.
2. Attach back plate to J-Box and secure with screws.
3. Complete the battery connection. (Fig. B)
4. Align snaps and push housing directly onto the back plate (Fig. C). Apply continuous AC power and press "TEST" button to check light.

INSTALLATION (CONDUIT)

1. Secure back plate to wall surface. Route wires through hole in conduit flange and make conduit connection. For 120V, use black and white wires and for 277V, use red and white wires.
2. Complete the battery connection (Fig. B).
3. Align snaps and push housing directly onto the back plate (Fig. C). Apply continuous AC power and press "TEST" button to check light.

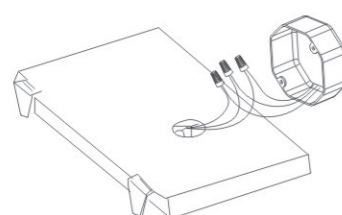

Fig.A (J-Box)

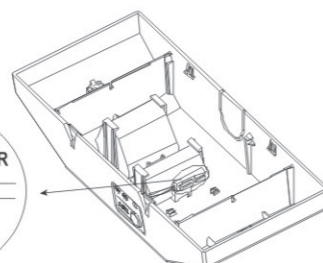
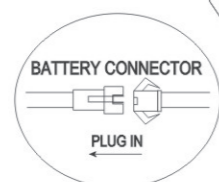

Fig.B

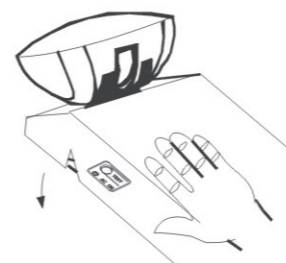

Fig.C

WARNING:

Unused wires must be capped using enclosed wire nuts.

OPERATION

1. During an electrical power failure, the LED lamps will automatically come on for a minimum of 90 minutes.
2. To test, depress the "TEST" switch. The emergency LED lamps will illuminate. When the switch is released, the lamps will go off.

WIRING DIAGRAM

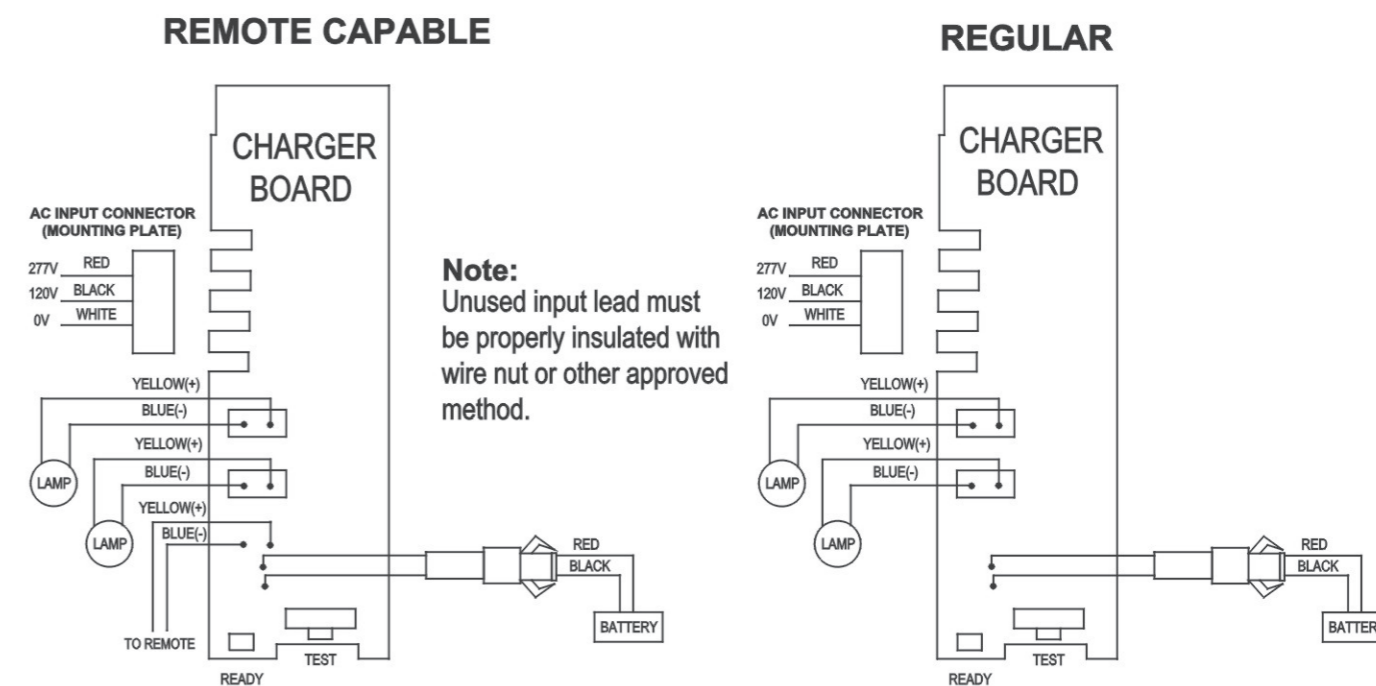

Questions, problems, missing parts?
Call ETi SSL Customer Service
8:30 a.m. – 5 p.m., EST, Monday - Friday
1-855-ETI-SSLI (1-855-384-7754)
www.etissl.com

Retain this manual for future use.

Imported by
ETI Solid State Lighting, Inc.
720 Corporate Woods Parkway
Vernon Hills, IL 60061

Made in China