

STRIP LIGHTS – DIRECT WIRE

0-10V DIMMING

Up to 4169 Delivered Lumens | Efficacy 127 LPW

KEY FEATURES

Each luminaire is 120-277V with 0-10V continuous dimming down to 10%. With a great efficacy rating of 118 LPW, and pleasant 4000K CCT, this product is perfect energy saving solution for traditional T8 lamps.

- Efficacy Rating: 4' = 127 LPW | 2' = 126 LPW
- Reported L91/54,000, Projected L70 @ 60,000 hours (min shown per IES TM21); 90% LED lumen maintenance at 54,000 hours
- Continuous 0-10V dimming down to 10%

SPECIFICATIONS

Construction

- Formed aluminum housing
- Post painted with reflective paint for ease of handling

Optics

- Non-yellowing PC lens material provides high light transmittance
- Semi-diffused, frosted, 1 mm thick secondary polymer lens. provides a uniform and soft visual appearance when in direct view with minimal LED pixelation and reduces glare

Installation

- Luminaire can be surface mount installed or as a pendant
- Surface mounting kit accessory available (sold separately)

Electrical

- 60,000 hour LEDs at L70 for reduced maintenance
- Operates at 120-277V, 50/60 Hz
- 0-10V dimming down to 10%
- Field installed accessories available:
BBU or External OC Sensor with Daylight Sensor*
**Cannot be installed together*

Warranty

5-Year Standard Warranty. See terms at: ETISSL.com/warranty/

KEY DATA	
Lumens (Delivered)	4' = 4169 2' = 2163
Wattage	4' = 34 2' = 17.1
Efficacy Range (LPW)	4' = 127 2' = 126
Reported Life (Hours)	L70 / 60,000

DATE:	PROJECT:
TYPE:	NOTES:
CATALOG #:	



Optional OC / Daylight Sensor available

Certifications & Test Data

- All luminaires are UL listed and are built for damp location use
- Adheres to LM79, and TM30 industry standards for photometric, lumen maintenance and lifetime calculations
- DLC® (DesignLights Consortium) Qualified. Please refer to DLC for specific product qualifications at www.designlights.org (See Page 2 for search info.)
- Driver rated for FCC part 15 Class B for use in residential or commercial applications

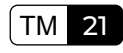
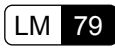

Strip Lights

CATALOG LOGIC

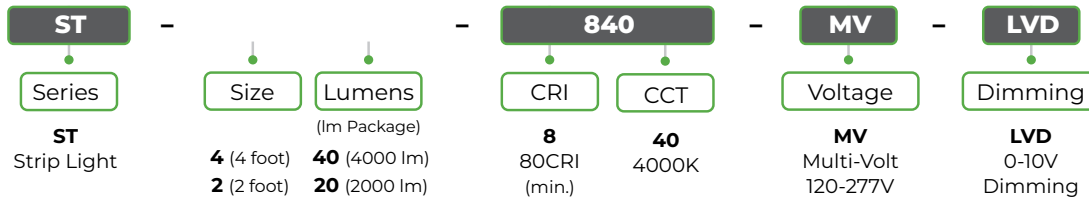

STANDARD STOCK ORDERING INFORMATION (typical 2-3 day shipment lead time)¹

Catalog Part Number	Order Number	Size	Replaces	Lumen Package	Delivered Lumens ²	Nominal Wattage	Efficacy	CCT	CRI	Volt.	Dim	DLC
ST-4-40-840-MV-LVD	54283144	4'	2 X 32W Fluorescent T8 Lamps	4000	4169	34	127	4000K	80+	120-277V	0-10V	Standard Search: 542831##-2
ST-2-20-840-MV-LVD	54260144	2'	1 X 32W Fluorescent T8 Lamps	2000	2163	17	126	4000K	80+	120-277V	0-10V	Standard Search: 542601##-2

Notes: 1. Stock SKUs typically ship in 24-48 hours upon receipt of an approved released order
2. For more delivered lumens and test data see on page 3, or visit ETISSL.com

AVAILABLE STOCK ACCESSORIES (must be ordered separately, field installed)

Emergency LED Driver/BBU² ⚠️ Not compatible with below Motion Sensor

Order Number	Description	Details
70112202-2 (EMA25FY-170)	Square Emergency LED Driver BBU 25W, IP rated, 90 min	 <p>BBUs certified in CA Title 20 MAEDBS. Search: EMA25FY-170 SPEC SHEET DOWNLOAD (located on ETISSL.com)</p>



Notes: 1. Also compatible with: 70114402-2 (40W, IP rated, 90 minutes, Square)
2. BBUs CANNOT be used or installed with below Motion Sensor

Motion Sensor¹ ⚠️ Not compatible with above BBU Products

Order Number	Description	Details
90600121	Multi-Volt Occupancy Sensor with daylight sensor, (External)	 <p>SPEC SHEET DOWNLOAD (located on ETISSL.com)</p>

Notes: 1. Motion Sensor CANNOT be used or installed with above BBUs

Mounting Accessories² (order separately, field installed)

Order Number	Description	Details
95457326101	Aircraft Cables for Suspending Mounting (Two 10' pieces)	 <p>PRODUCT LISTING (located on ETISSL.com)</p>
54657102	4" J-Box Surface Mounting Plate and Screws	 <p>PRODUCT LISTING (located on ETISSL.com)</p>

DIMENSIONS / DETAILS

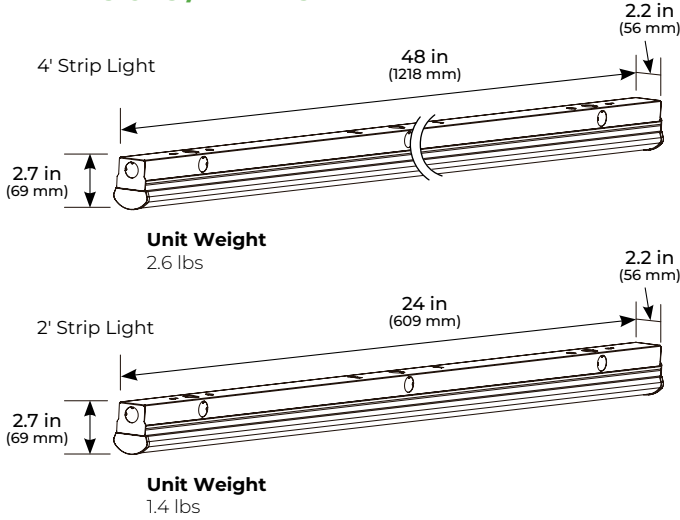

External Multi-Volt Occupancy Sensor with Daylight Sensor

- Up to 19' mounting height
- Detection angle 30 degrees to 150 degrees
- Knock out or link connection



PERFORMANCE / Data

Lumen Maintenance

Ambient Temp.	TM-21 Lumen Maintenance (54,000 hours)
25° C (77° F)	90%
Ambient Temp.	TM-21 Theoretical L70 (hours)
25° C (77° F)	60,000

Load Information

Power Factor	0.90
THD	< 20%
Frequency	50/60 Hz
Low Temp Start / Max Temp	-20°C (-4°F) / 45°C (113°F)

PHOTOMETRIC SAMPLES

4-FT

Luminaire Data: 4' at 4000K

CCT & CRI	4000K, 86 CRI
Initial Delivered Lumens	4169
Wattage	32.83W
Efficacy	127
Spacing	0° = 1.24 90° = 1.30

Photometric values based on tests performed in compliance with LM-63 & LM-79

Indoor Candela Plot

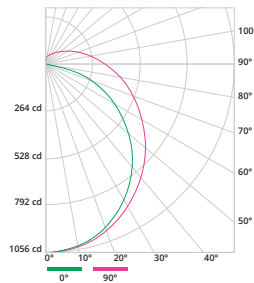

2-FT

Luminaire Data: 2' at 4000K

CCT & CRI	4000K, 86 CRI
Initial Delivered Lumens	2163
Wattage	17.11W
Efficacy	126
Spacing	0° = 1.24 90° = 1.30

Photometric values based on tests performed in compliance with LM-63 & LM-79

Indoor Candela Plot

