

2-HEAD LED SECURITY LIGHT

MODEL# 51405143 | 2544LUMENS | 28W | 94LPW | 4000K



2-HEAD LED SECURITY LIGHT

SUPERIOR VALUE & PERFORMANCE



PRODUCT OVERVIEW

ETi SSL's 2-Head LED Security Light has a lumen boost function which can be used to increase lighting coverage from 1200 Lumens to 2400 Lumens for broad and fuller light intensity. The light showcases a sensor which detects light or lack of light in specific areas and will ensure safety and awareness, preventing possible injuries and increase property value. Its dusk-to-dawn function can be used to control the lights to automatically turn on or off, or the included photocell cover can be used to control the fixture by switch. The 2-Head Security LED Light emits 28-watts of energy-efficient and cool emissions of premium LED technology conserving electricity, the environment, and your wallet.

Installation is easy due to its mounting bracket, and it highlights a toolless adjustability, enabling you to point heads in a desired direction. The 2-Head Security LED Light is maintenance-free, so there is no need to climb ladders to replace bulbs. Because of its housing of lightweight aluminum, it is suitable for wet locations.

Our entire team takes great pride in our dedication to providing innovative in-stock lighting solutions that typically ship in 2-3 days with the product reliability and quality that you can always depend on from ETi SSL.

STOCK ORDERING INFORMATION (typical 2-3 day shipment lead time)¹

Catalog Logic/PT#	Model #	UPC	Lumens ²	Wattage	LPW	CCT	CRI	Voltage	Dimming	Energy Star ³
SC-2HD-2400LM-8-40K-SV-BZ	51405143	849489065670	2544lm	26.9	94	4000K	80 (min)	120V	Non-Dim	Yes

Notes:

1. Stock SKUs typically ship in 24-48 hours upon receipt of an approved released order.
2. This unit has Lumen Boost settings from 50% (1200 nominal lumens) to 100% (2400 nominal lumens). This unit test results are for the highest setting (2544lm).
3. Search first 6-digits of the model # followed by '##' on the ENERGY STAR® website database...(Ex: '514051##') to view certifications.







SC Series

2-Head LED Security Light

Model# 51405143 | 2544Lumens | 28W | 94LPW | 4000K | ENERGY STAR® | 5-yr Warranty

CATALOG LOGIC | PART# DECODER^{1,2,3}

SC-2HD-2400LM-8-40K-SV-BZ (Model # 51405143)

						
Series	Size	Lumens ³	CRI	CCT	Voltage	Bronze
SC Security Light	2HD 2-Head	2400LM Nominal Lumens	8 80CRI (minimum)	40K 4000K	SV Single Voltage (120V)	BZ Bronze Finish

Notes:

1. This product is not configurable, only designated 'Stock' SKUs are available.
2. Decoder is to help clarify Catalog Logic|Part # configurations only (see Stock & Rapid Ship Ordering Information for available SKUs).
3. Lumen values shown are nominal (see Stock Ordering Information or Photometric Details sections for additional performance details).

KEY DIMENSIONAL INFORMATION

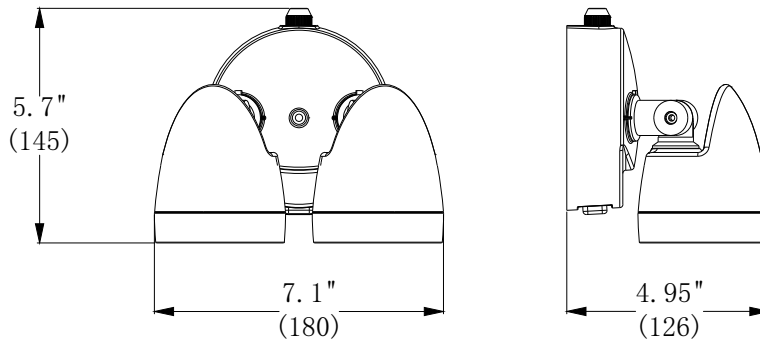

Note: All dimensions are shown in inches (millimeters).

MISCELLANEOUS PRODUCT SPECS & DETAILS

Load Information

Power Factor	> 0.9775
THD	< 41%
Frequency	60 Hz
Sound Rating	< 20 Dba
Low Temp Start	-40° C (-40° F)
Max Temp	45° C (113° F)
Unit Weight	1.92 lbs

Lumen Maintenance

Ambient Temperature	TM-21 Lumen Maintenance (60,000 hours)
25° C (77° F)	> 88.25%
Ambient Temperature	TM-21 Theoretical L70 (hours)
25° C (77° F)	168,000

Shipping Information*

Size	Unit Weight ¹	Pallet ²
2-Head Unit	2.29 lbs	84 units

1. Case pack weighs 10.25lbs (4 units / per case pack).
2. There are 42 case packs per pallet.

PHOTOMETRIC DETAILS

Luminaire Data: SC-2HD-2400LM-8-40K-SV-BZ

IES File Name	51405143_51405144.IES
CCT & CRI	4000K, 80CRI minimum
Initial Delivered Lumens	2,544
Wattage	26.97W
Efficacy	94
Beam Angle	50% = 72° 10% = 120°
Spacing	0° = 1.10 90° = 1.20

Photometric values based on tests performed in compliance with LM-63 & LM-79

Indoor Candela Plot

