

3-HEAD LED SECURITY LIGHT  
WITH LUMEN BOOST & COLOR PREFERENCE®

MODEL# 514032110 | 4051LUMENS | 38.7W | 104.6LPW | 3-CCT



3-HEAD LED SECURITY LIGHT WITH LUMEN BOOST & COLOR PREFERENCE®

**SUPERIOR VALUE & PERFORMANCE**



**PRODUCT OVERVIEW**

ETi SSL's 3-Head LED Security Light has a lumen boost function which can be used to increase lighting coverage from 1800 nominal lumens to 3600 nominal lumens (4051lm based on IES test data) for broad and fuller light intensity. The light showcases a motion sensor with 240° coverage and timer or dusk-to-dawn function that will ensure safety and awareness, preventing possible injuries and increase property value. Adjust the motion sensor sensitivity detection range up to 60 ft. and set the timer up to 10 minutes. The dusk-to-dawn photocell enables you to control the lights from sunset to sunrise. The 3-Head Security LED Light emits 38.7-watts of energy-efficient and cool emissions of premium LED technology conserving electricity, the environment, and your wallet.

Installation is easy due to its mounting bracket, and it highlights a tool-less adjustability, enabling you to point heads in a desired direction. The 3-Head Security LED Light is maintenance-free, so there is no need to climb ladders to replace bulbs. Because of its housing of lightweight aluminum, it is suitable for wet locations.

Our entire team takes great pride in our dedication to providing innovative in-stock lighting solutions that typically ship in 2-3 days with the product reliability and quality that you can always depend on from ETi SSL.

**STOCK ORDERING INFORMATION** (typical 2-3 day shipment lead time)<sup>1</sup>

Catalog Logic/PT#	Model #	UPC	Lumens <sup>2</sup>	Wattage	Sensor	LPW	3-CCT <sup>3</sup>	CRI	Voltage	Dimming	Energy Star <sup>4</sup>
SC-3HD-3600LM-8-CP3-SV-OS-BZ	514032110	849489066745	4051lm	38.7	240°	104.6	3000K 4000K 5000K	80 (min)	120V	Non-Dim	Yes

Notes:









1. Stock SKUs typically ship in 24-48 hours upon receipt of an approved released order.
2. This unit has Lumen Boost settings from 50% (1800 nominal lumens) to 100% (3600 nominal lumens). This unit test results are for the highest setting (3600lm)
3. Factory set to 3000K.
4. Search first 6-digits of the model # followed by '##' on the ENERGY STAR® website database...(Ex. '5140321##') to view certifications.

# SC Series

3-Head LED Security Light with Lumen Boost & Color Preference®  
 Model# 514032110 | 4051 Lumens | 38.7W | 104.6LPW | 3-CCT | ENERGY STAR® | 5-yr Warranty

## CATALOG LOGIC | PART# DECODER<sup>1,2,3</sup>

### SC-3HD-3600LM-8-CP3-SV-OS-BZ (Model # 514032110)

							
Series	Size	Lumens <sup>3</sup>	CRI	CCT	Voltage	Sensor	Color
<b>SC</b> Security Light	<b>3HD</b> 3-Head	<b>3600LM</b> Nominal Lumens	<b>8</b> 80min CRI	<b>CP3</b> Color Preference® 3-CCT (3000K, 4000K, 5000K)	<b>SV</b> Single Voltage (120V)	<b>OS</b> Occupancy Sensor 240° Range	<b>BZ</b> Bronze Finish

Notes:  
 1. This product is not configurable, only designated 'Stock' SKUs are available.  
 2. Decoder is to help clarify Catalog Logic|Part # configurations only (see Stock Ordering Information for available SKUs).  
 3. Lumen values shown are nominal (see Stock Ordering Information or Photometric Details sections for additional performance details).

## KEY DIMENSIONAL INFORMATION

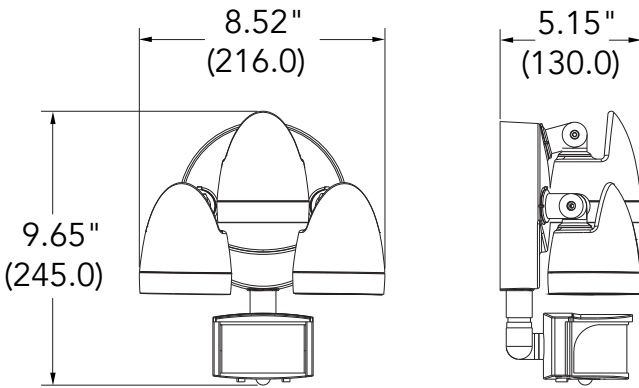

Note: All dimensions are shown in inches (millimeters).

## MISCELLANEOUS PRODUCT SPECS & DETAILS

### Load Information

Power Factor	> 0.90
THD	< 20%
Frequency	60 Hz
Sound Rating	< 20 Dba
Low Temp Start	-20° C (-4° F)
Max Temp	45° C (113° F)
Unit Weight	3.19 lbs

### Lumen Maintenance

Ambient Temperature	TM-21 Lumen Maintenance (60,000 hours)
25° C (77° F)	> 88.3%
Ambient Temperature	TM-21 Theoretical L70 (hours)
25° C (77° F)	169,000

### Shipping Information\*

Size	Unit Weight <sup>1</sup>	Pallet <sup>2</sup>
3-Head Unit	3.72 lbs	84 units

1. Case pack weighs 15lbs (4 units / per case pack).  
 2. There are 42 case packs per pallet.

## INCLUDED IN BOX



## PHOTOMETRIC DETAILS

### Luminaire Data: SC-3HD-3600LM-8-CP3-SV-OS-BZ

IES File Name	514032120_514032110.IES
CCT & CRI	3-CCT, 80CRI minimum
Initial Delivered Lumens	4,051
Wattage	38.7W
Efficacy	104.6
Beam Angle	50% = 78° 10% = 134.2°
Spacing	0° = 1.10 90° = 1.08

Photometric values based on tests performed in compliance with LM-63 & LM-79

### Indoor Candela Plot

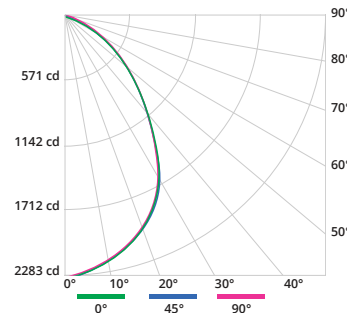

ETI Solid State Lighting  
 720 Northgate Parkway, Wheeling, IL 60090

1.855.384.7754 | www.ETISSL.com | etiorders@ETISSL.com

All specifications are subject to change without notice.  
 All reported values are nominal or typical values, measured under laboratory conditions @ 25° C (77° F).  
 Actual performance can vary slightly as a result of end-user application & environment.